

RIGHT ANGLE DRILL

DW955-----B

TYPE 2

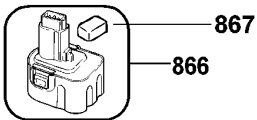
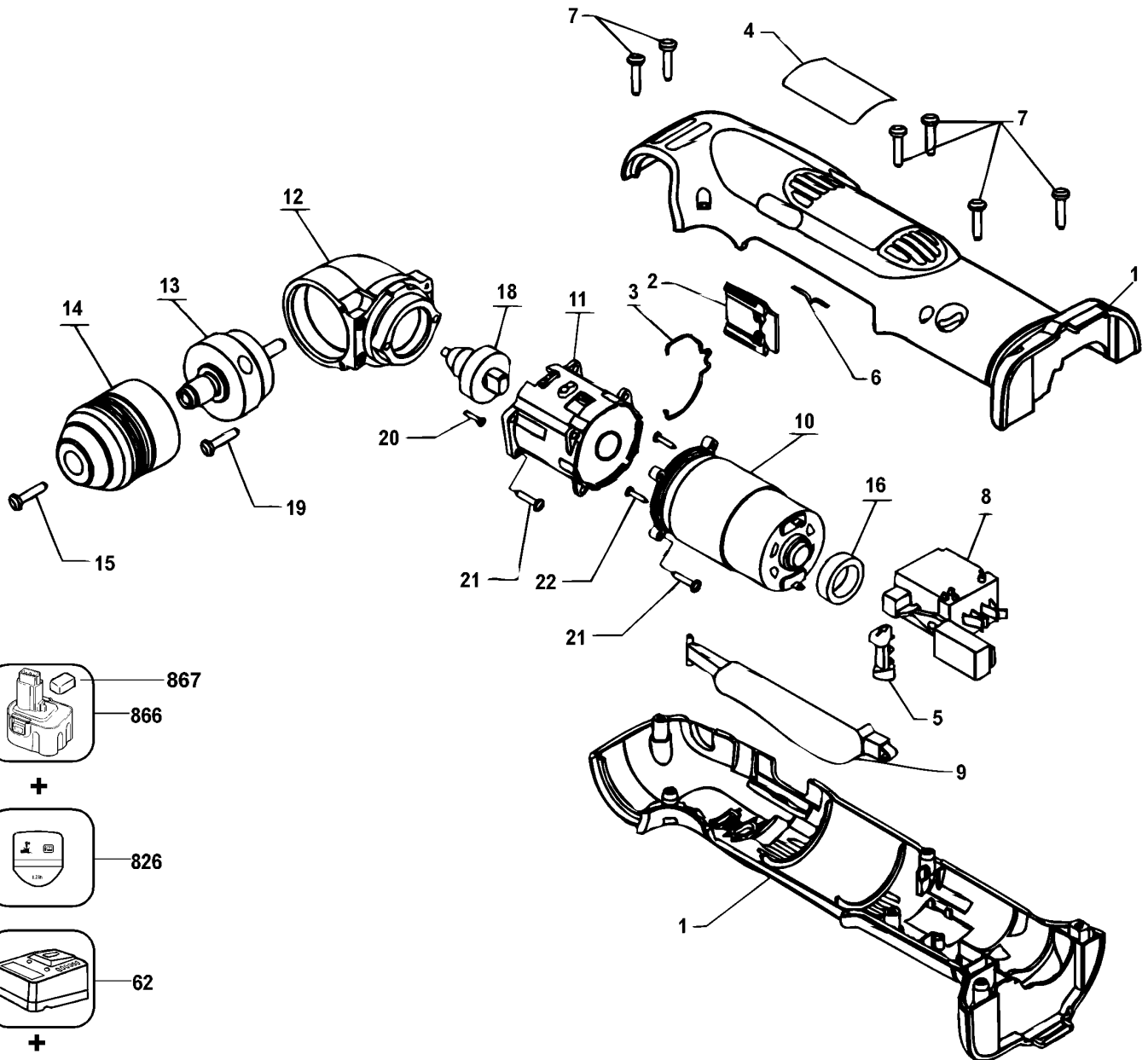

+

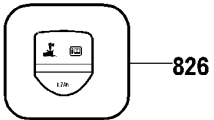

+

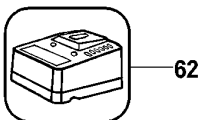

+

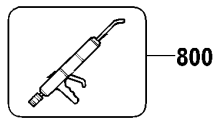
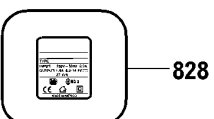
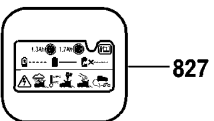

©

RIGHT ANGLE DRILL

DW955-----B

TYPE 2



| Item No | Qty | Part Number | Description | Part Price | Variants |
|---------|-----|-------------|-------------------|------------|----------|
| 1 | * 1 | 383841-08 | CLAMSHELL SET | | |
| 2 | 1 | 383842-02 | ACTUATOR | | |
| 3 | 1 | 383184-00 | SPRING | | |
| 4 | 1 | 149490-00 | BRAND LABEL | | |
| 5 | 1 | 383843-00 | SLIDER | | |
| 6 | 1 | 144658-00 | SPRING | | |
| 7 | * 1 | 330019-00 | SCREW | | |
| 8 | 1 | 152274-13 | SWITCH | | |
| 9 | 1 | 383844-00 | PADDLE | | |
| 10 | 1 | 391886-00 | MOTOR & PINION | | |
| 11 | 1 | 383839-00 | GEARBOX SA | | |
| 12 | *1 | 383837-00 | GEARCASE | | |
| 13 | 1 | 383840-00 | SPINDLE & GEAR | | |
| 14 | *1 | 330075-46 | CHUCK KEYLESS | | |
| 15 | 1 | 605256-02 | SCREW | | |
| 16 | *1 | 391564-00 | SPACER | | |
| 18 | 1 | 386492-00 | PINION & GEAR SA | | |
| 19 | 1 | 80164-00 | SCREW | | |
| 20 | 1 | 55206-00 | SCREW | | |
| 21 | 8 | 98091-10 | SCREW | | |
| 22 | 2 | 156179-00 | SCREW | | |
| 62 | 1 | 572576-00 | CHARGER 240V | | |
| 800 | 1 | 283484-01 | GREASE | | |
| 800 | 1 | 284778-00 | GREASE | | |
| 800 | 1 | 761995-01 | GREASE 180 GMS | | |
| 826 | 1 | 578763-01 | IDENTITY LABEL | | |
| 827 | 1 | 643500-00 | WARNING LABEL | | |
| 828 | 1 | 583471-05 | NAMEPLATE | | |
| 866 | 1 | 582803-00 | BATTERY PACK 9.6V | | |
| 867 | 1 | 608522-00 | SAFETY CAP | | |